

NAPKIN FOLDS

Shown below are typical napkin folds that can be produced on Bretting Manufacturing equipment. Please contact a Bretting Sales Representative about your particular product size and design.

INTERFOLDED NAPKIN (2, 3, 4 Panel Available)

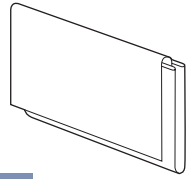

1

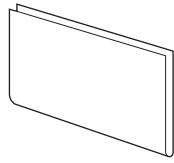

2

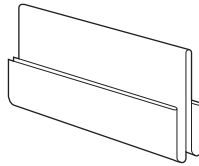

3

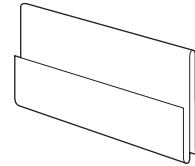

4

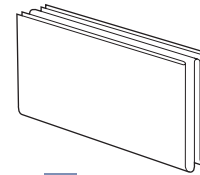

5

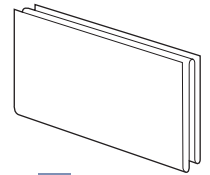

6

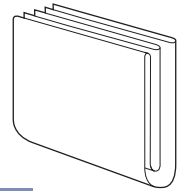

7

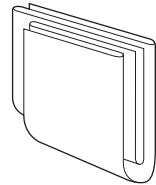

8

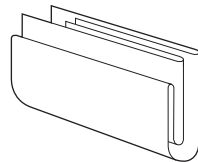

9

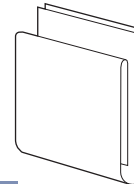

10

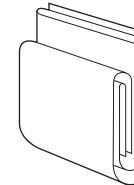

11

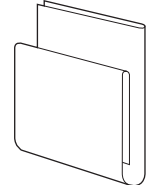

12

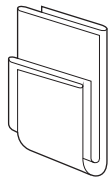

13

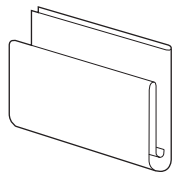

14

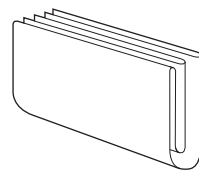

15

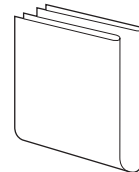

16

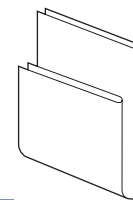

17

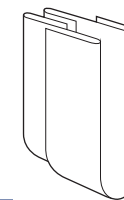

18

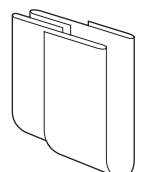

19



C. G. Bretting Manufacturing Co., Inc.
3401 Lake Park Road
Ashland, Wisconsin 54806 USA
+1 715 682 5231
cgb@bretting.com | www.bretting.com

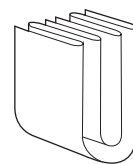

20

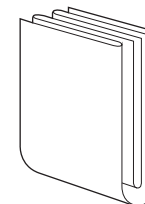

21

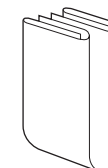

22

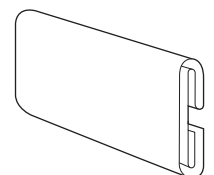

23

INTERFOLDER FOLDS

Shown below are typical interfolder folds that can be produced on Bretting Manufacturing equipment. Please contact a Bretting Sales Representative about your particular product size and design.

SINGLEFOLD PRODUCT

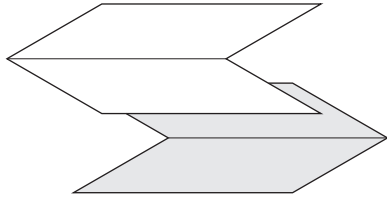

2 PANEL

2, 3, 4-PANEL PRODUCT

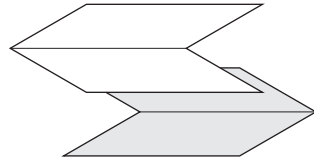

2 PANEL

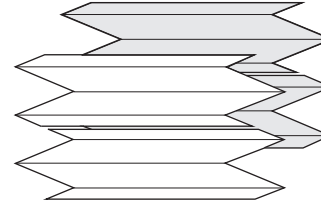

3 PANEL

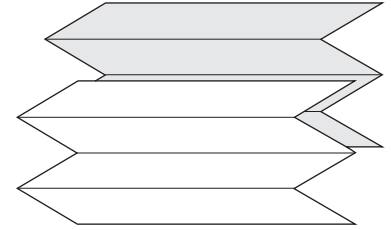

4 PANEL

MULTIFOLD PRODUCT

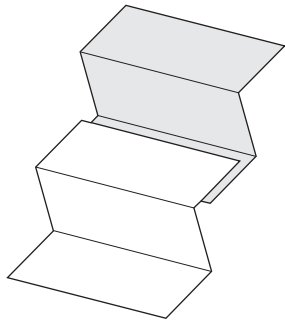

3 PANEL

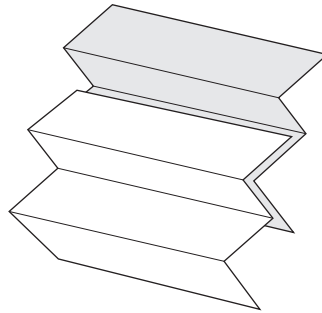

4 PANEL

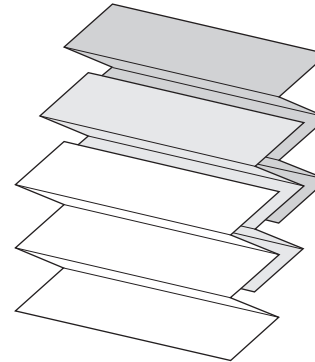

5 PANEL

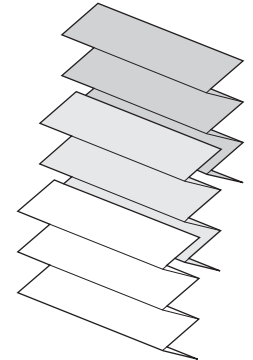

6 PANEL

BATH TISSUE PRODUCT

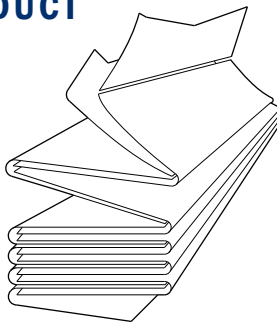

FACIAL TISSUE PRODUCT

CLEAN CUT

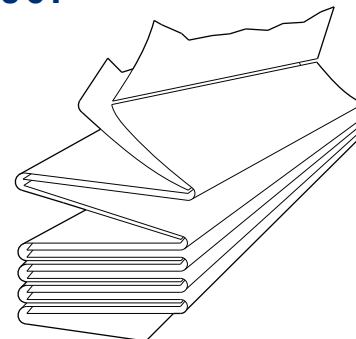

TAB BOND

